

HARVEY INDUSTRIES, INC.

935 MOE DRIVE • AKRON, OHIO 44310-2518 • 330.633.0122 • FAX 330.633.0320

CARBON MONOXIDE AND TOXIC FUME REMOVAL SYSTEMS/ACCESSORIES



□ (ABOVE) HRX-812 EXHAUST RAIL
(BELOW) OVERHEAD TELESCOPIC EXHAUST SYSTEM

HRX-812 EXHAUST RAIL

The Harvey Exhaust Rail is designed to efficiently and effectively remove exhaust fumes from any type of service facility. Heavy Duty construction of the extruded aluminum rail guarantees its long, maintenance-free life. Thick wall construction of the rubber seal provides a secure, airtight fit. The positive pull connection system ensures proper alignment of each section of rail. The easy glide trolley assembly construction provides the ability to effortlessly move the trolleys down the rail.

HARVEY INDUSTRIES, INC.—We take pride in providing personalized service and assistance to every customer. Our customer service department is ready to assist you with product application questions, design and installation inquiries, or matters related to shipment. We maintain strict quality control standards and stand behind every product sold. Most products are inventoried and can be shipped from stock, with special orders and systems taking slightly longer.



□ CONNECTING HOSE, CLAMPS, AND STOP COLLAR ARE INCLUDED WITH THE HOSE REEL.

OVERHEAD EXHAUST SYSTEM MODELS #TS-30 & #TS-40

HARVEY'S "TELESCOPICALLY"[®] DESIGNED OVERHEAD EXHAUST DROP #TS-30 AND #TS-40 WITH NON-CRUSH TUBING AND ADAPTER (HAVING SECTIONS WHICH SLIDE ONE INTO ANOTHER).

THE HARVEY AUTOMATIC RETRACTABLE HOSE REEL offers one of the most convenient methods available for extracting harmful exhaust fumes and gases from all types of service areas. The carbon spring-operated hose reel is designed for years of trouble-free service and can be adapted for use with ALL TYPES of vehicles. The exhaust hose supplied with the reel is fabricated of Silicone Fiberglass with an internal wire helix and rubber coated. It is high heat resistant to 600° and meets U.S. Military and commercial specifications as well as United States Air Force requirements for high temperature stability.

A Harvey Exhaust System is the safe and sure way to remove harmful toxic gases. Harvey systems can be engineered for new or existing buildings, providing minimum installation costs and maintenance. Types of Harvey systems included underfloor, overhead, thru-the-door, thru-the wall, welding exhaust, and automatic retracting hose reel, providing the proper ventilation for automobiles, light-duty and diesel trucks, buses, tractors, toxic fume and welding exhaust.

For assistance in layout or engineering specifications, please contact our factory or local representative.

We'll be pleased to assist you in layout and design of all systems. Harvey Industries has analyzed the serviced requirements of all makes of cars, trucks, and buses. Special attention has been given to the installation and construction needs of every exhausting problem, from new construction to renovation or upgrading of existing systems. We suggest your exact requirements be supplied to us for our recommendations.



COMPLETE ENGINEERING AND TECHNICAL THREE RING BINDER AVAILABLE UPON REQUEST.



□ THE HARVEY AUTOMATIC RETRACTABLE HOSE REEL

THE HARVEY AUTOMATIC RETRACTABLE HOSE REEL offers one of the most convenient methods available for extracting harmful exhaust fumes and gases from all types of service areas. The spring-operated hose reel is designed for years of trouble-free service and can be adapted to ALL types of vehicles.

The exhaust hose supplied with the reel is fabricated of Silicone Fiber-glass with an internal wire helix and rubber coated. It is high heat resistant to 600°F and meets U.S. Military and commercial specifications as well as United States Air Force requirements for high temperature stability.

A Harvey Hose Reel is shipped prewound and complete with the following components:

Retracting hose reel with automatic recoil, lock, and latch, SF exhaust hose, 4"x6" duct connecting exhaust tube with clamps, tailpipe adapter, stop collar with clamps.

- | | |
|---------------|---|
| RHR-4R | Reel and components, 25' x 4" HOSE ASSEMBLY |
| RHR-5R | Reel and components, 25' x 5" HOSE ASSEMBLY |
| RHR-6R | Reel and components, 25' x 6" HOSE ASSEMBLY |

The following reels are supplied with 18' of SF exhaust hose and 8' of neoprene rubber tubing at the bottom.

- | | |
|------------------|------------------|
| RHR-3R-NR | RHR-4R-NR |
| RHR-5R-NR | |

Motorized reels and reels with micro switch also available, please contact local representative or factory.

NOTE: Hose extensions are available if standard length supplied with reel is not adequate.

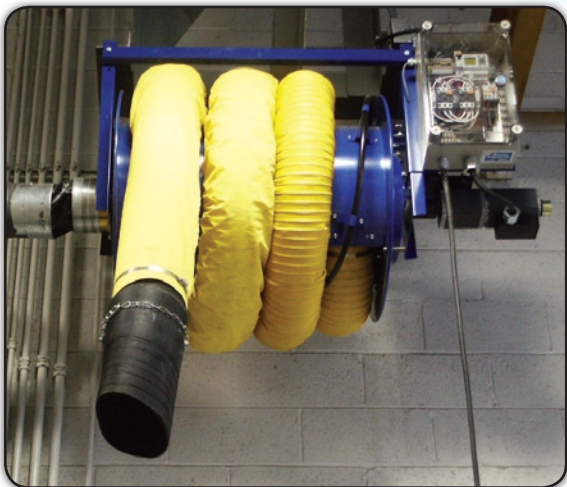

□ RHR-MHR HOSE REEL SERIES



RHR-DX HOSE REEL SERIES

The DX Hose Reel Series integrates a direct drive pressure blower creating a complete stand alone extraction package. Any of the standard hose reels can be fitted with a 3/4 to 3 horse power direct drive blower to suit any application. Contact factory for sizing information.

HARVEY OVERHEAD EXHAUST RAIL & TELESCOPIC SYSTEMS

HARVEY

INDUSTRIES, INC.



HARVEY OVERHEAD EXHAUST SYSTEM-MODEL #TS-30 (TELESCOPIC® DESIGN)

HARVEY'S "TELESCOPICALLY®" Designed Overhead Exhaust Drop #TS-30 with Non-Crush Tubing and Adapter (having sections which slide one into another)

The Harvey model #TS-30 is "TELESCOPICALLY®" designed to simplify and improve upon existing overhead exhaust drops currently available. The #TS-30 consists of three lengths of light weight flexible tubing which slide one into another and give the appearance of only one 6' length of tubing attached to the overhead duct.

The tubing and tailpipe adapter which connect to vehicle are non-crush neoprene rubber. Drive over it! The tubing and adapter can not be crushed or damaged. Pull-up sets are not required with the #TS-30 & #TS-40 drops.

FEATURE

NON-CRUSH NEOPRENE RUBBER (600 DEGREES)
TUBING "TELESCOPICALLY®" DESIGNED
NON-CRUSH NEOPRENE RUBBER (600 DEGREES)
TAILPIPE ADAPTER ONE SIZE TAILPIPE ADAPTER
FITS ALL EASE OF INSTALLATION

BENEFIT

DRIVE OVER IT! THE TUBING WILL NOT CRUSH OR HAVE TO BE REPLACED LIKE HOSE WITH AN INTERNAL WIRE HELIX.

ELIMINATES THE HANGING "ELEPHANT TRUNKS" AS WELL AS HAND OR WINCH TYPE PULL UP SETS.

WILL NOT SCRATCH VEHICLE OR CHROME EXHAUST PIPES. CAN BE DRIVEN OVER WITH NO HARM TO THE ADAPTER OR VEHICLE

NOT NECESSARY TO SWITCH ADAPTERS OR USE ADDITIONAL ACCESSORIES.

SHIPPED COMPLETELY ASSEMBLED, SUPPLIED WITH GALVANIZED SLEEVE THAT SLIPS OVER 5" STUB OR "T" OF DUCT WORK.

MODEL #TS-40 IN STOCK FOR MEDIUM AND LIGHT DUTY DIESEL VEHICLES WHERE 3" TUBING IS INADEQUATE.

CARBON MONOXIDE AND TOXIC FUME EXHAUST SYSTEMS • BLOWERS • HOSES • ACCESSORIES



HARVEY HRX-812 EXHAUST RAIL

Elliptically shaped aluminum rail allows for efficient airflow and sleek styling

Easy-glide trolley assembly allows drops to be shared among bays (check state and local codes)

12' standard rail length for ease of installation – custom lengths also available

Pinned joints to guarantee easy alignment of rail sections

"Positive Pull" – nut & bolt joining system with gasketed seams to ensure a simple, trouble-free installation

Trolley assembly can be fitted with the standard TS-30 drop or the #3-Skyhook balancing pull-up configuration

Heavy duty trolley assembly is fitted with eight ball bearing wheels for smooth operation



HARVEY HRX-812 EXHAUST RAIL

- SLEEK STYLING
- EASY TO INSTALL
- HEAVY DUTY CONSTRUCTION
- EASY-GLIDE TROLLEY MOVEMENT
- EFFICIENT AIRFLOW



□ STANDARD OVERHEAD SYSTEMS

An overhead system is easily installed in an existing or new building. A single drop is normally located at the side of the stall approximately 1' behind rear vehicle bumper. The ductwork should be at an elevation of 15' to 16' A.F.F., which would then allow the standard 20' hose drop to attach to either right or left side mounted tailpipes. An overhead drop is installed by slipping the overhead coupler over the appropriate size stub or air flow "T" of the ductwork. The overhead coupler is held in place with a bolt through the assembly. FOR DUAL EXHAUST VEHICLES A "Y" HARNESS SHOULD BE USED IN CONJUNCTION WITH THE OVERHEAD DROP. Various types of pull-up sets are available to retract hose drops when not in use, such as Harvey's No. 1, 2, or 3 Skyhooks.

OH-30/40 DROP ASSEMBLY

| PART NO. | COMPONENTS |
|-----------|---|
| OH-30-47 | 20' x 3" neoprene rubber hose, OHC-30 overhead duct coupler, ES-130 energy saving damper, HF-477 rubber tailpipe adapter. |
| OH-30-57 | 20' x 3" neoprene rubber hose, OHC-30 overhead duct coupler, ES-130 energy saving damper, HF-577 rubber tailpipe adapter. |
| OH-30-L47 | 20' x 3" neoprene rubber hose, OHC-30 overhead duct coupler, H-3AEL Lifting Elbow, HF-477 rubber tailpipe adapter. |
| OH-30-L57 | 20' x 3" neoprene rubber hose, OHC-30 overhead duct coupler, H-3AEL Lifting Elbow, HF-577 rubber tailpipe adapter. |
| OH-40-57 | 20' x 4" neoprene rubber hose, OHC-40 overhead duct coupler, ES-140 energy saving damper, HF-577 rubber tailpipe adapter. |

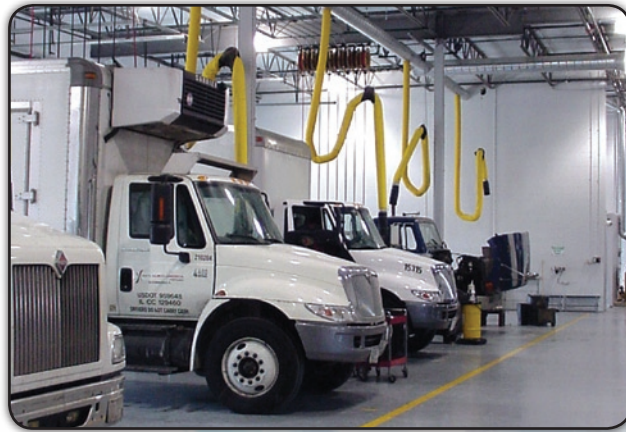

□ DIESEL EXHAUST SYSTEMS

OH-40/50 DROP ASSEMBLY FOR DIESEL APPLICATIONS

| PART NO. | COMPONENTS |
|-----------|--|
| OH-40-L57 | 20' x 4" neoprene rubber hose, OHC-40 overhead duct coupler, H-4AEL Lifting Elbow, HF-577 rubber tailpipe adapter. |
| OH-40-D | 20' x 4" neoprene rubber hose, OHC-40 overhead duct coupler, ES-140 energy saving damper, H-491 diesel adapter. |
| OH-40-DL | 20' x 4" neoprene rubber hose, OHC-40 overhead duct coupler, H-4AEL Lifting Elbow, H-491 diesel adapter. |
| OH-40-D11 | 10' x 4" neoprene rubber hose, OHC-40 overhead duct coupler, H-491 diesel adapter. |
| OH-50-D11 | 10' x 5" neoprene rubber hose, OHC-50 overhead duct coupler, H-491 diesel adapter. |

DIESEL EXHAUST SYSTEMS CONTINUED

Overhead diesel systems are also available in 4" – 5" & 6" SILICONE FIBERGLASS drops.

Standard Lengths are 12' and 24'. Custom lengths and larger diameters are also available.

PLEASE CONTACT FACTORY.

PART NO. COMPONENTS

OH-40-DS12 12' X 4" Silicone Fiberglass hose, AR-4 neoprene rubber adapter.

OH-40-DST12 12' X 4" Silicone Fiberglass hose, TAC-4 tapered S.S. adapter with spring cover.

OH-40-DSH12 12' X 4" Silicone Fiberglass hose, TA-4 tapered S.S. adapter with hand damper at base of adapter.

OH-40-DS24 24' X 4" Silicone Fiberglass hose, AR-4 neoprene rubber adapter.

OH-40-DST24 24' X 4" Silicone Fiberglass hose, TAC-4 tapered S.S. adapter with spring cover.

OH-40-DSH24 24' X 4" Silicone Fiberglass hose, TA-4 tapered S.S. adapter with hand damper at base of adapter.

TO ORDER 5" OR 6" DIAMETER DROPS SIMPLY SUBSTITUE "50" OR "60" IN PLACE OF "40" IN THE ABOVE PART NO. Positioning Poles to Place the adapter on an overhead stack while standing on the floor are available.

PART #H-SO-P CONSISTS OF: 8' POSITIONING POLE AND NEOPRENE RUBBER ADAPTER WITH STANDOFF. SPECIFY HOSE DIAMETER.



☐ #1 Skyhook



☐ #2 Skyhook

HARVEY PULL-UP SETS FOR OVERHEAD SYSTEMS

#1 Skyhook: Hose saddle, 50' x 1/4" nylon rope, 2 pulleys, wall-mounted hand winch.

#1-C Skyhook: Same as above except 1/8" aircraft cable in place of rope.

#2 Skyhook: Hose saddle, 50' x 1/4" nylon rope, 2 pulleys, wall cleat.

HARVEY BALANCER FOR OVERHEAD SYSTEMS

Capable of retracting up to 4" I.D., hose or tubing.

#3 Skyhook: Harvey retracting cable reel with hose saddle.

An Adjustable cable stop makes it easy to set the overhead drop at desired height.

WHEN SKYHOOKS ARE USED FOR TUBING OTHER THAN RUBBER, THE APPROPRIATE HARDWARE IS SUPPLIED IN PLACE OF A HOSE SADDLE.

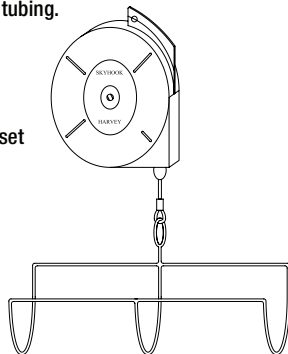

HARVEY SPECIALTY EXHAUST HOSE

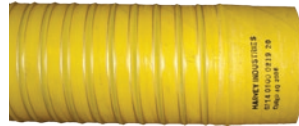

☐ SF-HARVEY HIGH TEMPERATURE EXHAUST HOSE

SF-HARVEY HIGH TEMPERATURE EXHAUST HOSE

Fabricated of Silicone Fiberglass with an internal wire helix and rubber coated. It is high heat resistant to 600°F and meets U.S. military and commercial specifications as well as United States Air Force requirements for high temperature stability. Standard lengths are easily coupled together. PLEASE CONTACT FACTORY.

| PRODUCT NO | SIZE (I.D.) | LENGTH |
|------------|-------------|--------|
| SF-3 | 3" | 12' |
| SF-4 | 4" | 12' |
| SF-5 | 5" | 12' |
| SF-6 | 6" | 12' |

Hoses rated up to 2000° available. PLEASE CONTACT FACTORY.



☐ WHT-HARVEY WELDING HOSE

WHT-HARVEY WELDING HOSE

Vinyl/Glass type with Helix (Vinyl Coated) 300°F Maximum Temperature

| PRODUCT NO | SIZE (I.D.) |
|------------|-------------|
| WHT-4 | 4" |
| WHT-5 | 5" |
| WHT-6 | 6" |

WELDING EXHAUST HOOD

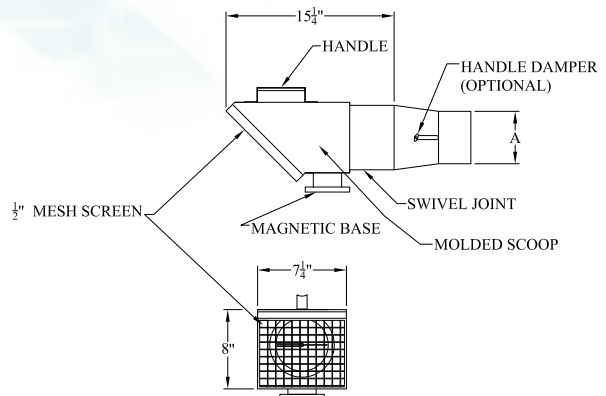

WELDING HOOD-#WH

| MODEL NO. | HOSE I.D. |
|-----------|-----------|
| WH-4 | 4" |
| WH-5 | 5" |
| WH-6 | 6" |
| WH-8 | 8" |

“FLUSH” MOUNT FLOOR UNITS WITH RECESSED HINGES AVAILABLE TO ACCOMMODATE AUTOMATIC CONCRETE SCREEDING MACHINES.

GENERAL SPECIFICATIONS

The body of the P S Floor Fitting is plastic, molded from high-temperature resistant polyethylene. The top flange and lid of the P S Fitting is cast aluminum with the 5/16" – thick lid having a tensile strength of 35,000 lbs. The lid is attached to the flange with a heavy-gauge, all S.S., piano hinge for easy maintenance.



□ UNDERGROUND SYSTEM

UNDERGROUND PRODUCT SELECTION CHART FOR PASSENGER CARS, LIGHT & MEDIUM DUTY TRUCKS OR BUSES

| PRODUCT NUMBER | HOSE SIZE |
|----------------|--------------------|
| UF-PS-30 | 3" neoprene rubber |
| UF-PS-40 | 4" neoprene rubber |

* 4" hose or tubing is recommended for medium duty trucks or buses. Complete underground units in the chart above include the following components:

- | | |
|---------------------------------|---------------------------------|
| 1- Molded plastic floor fitting | 1- 8' length of hose or tubing |
| 1- Molded plastic pipe saddle | 1- Appropriate tailpipe adapter |
| | 1- Hose or tube guide |

To order floor fitting and saddle only, delete UF in part number.

UNDERGROUND PLUG-IN TYPE EXHAUST SYSTEMS (NON-DISAPPEARING)

THE “PLUG-IN” Type exhaust systems is for those installations that do not require the storage of the exhaust hose inside the underground pipe. The exhaust hose is conveniently stored in the work bay area and is simply “plugged” (using elbow supplied with complete “Plug-In” units) into the floor fitting and attached to the vehicle exhaust pipe when needed. The Harvey “PLUG-IN” floor fitting will accommodate two 3” hoses, one 3” hose, one 4” hose, or one 5” hose.

GENERAL SPECIFICATIONS

The “Plug-In” Kits have the same specifications as the PS-30 kits noted above. The body of the floor fitting and the saddle are molded plastic. The top flange and the lid of the floor fitting are cast aluminum with all S.S. piano hinge.

Installation of the “Plug-In” Saddle would be basically the same as noted above for the P S molded plastic pipe saddle.

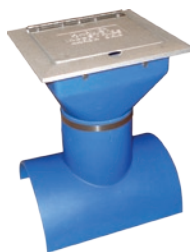

□ PI KIT

UNDERGROUND SYSTEM

When in the open position, the lid rests solidly on the floor. The molded plastic Floor Fitting offers reduced costs and is impervious to all the elements for years of trouble-free service. The base is designed to fit the Harvey Molded Plastic Pipe Saddle, which allows for approximately 4" height adjustment.



MOLDED PLASTIC SLANT FLOOR FITTING WITH CAST ALUMINUM FRAME & LID

HARVEY MOLDED PLASTIC PIPE SADDLE INSTALLATION

The Harvey Molded Plastic Pipe Saddle minimized material and labor costs related to installation. The saddle is molded from high-temperature resistant, cross-link polyethylene and is impervious to the elements. Using the template provided, a hole is cut in the pipe wherever a Floor Fitting is to be positioned, normally on the stall center line 1 foot behind the rear bumper. Apply a heavy layer of mastic caulking compound to that portion of the saddle which sets on the pipe. Position the saddle on the pipe and attach with the S.S. straps provided.

The Harvey Molded Plastic Saddle is universal for all types of underground pipe (specify pipe size). Pipe recommendations: (P.V.C. Sched. 40 or Sched. 80, or similar type of pipe). CONSULT STATE/LOCAL BUILDING CODES.

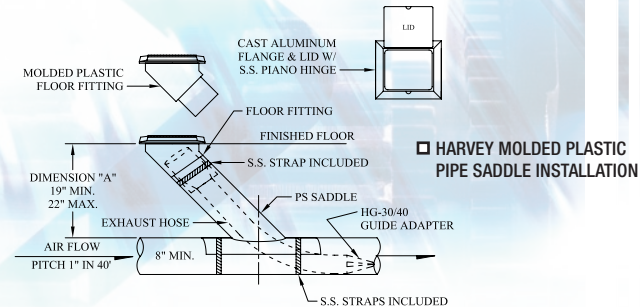

□ HARVEY MOLDED PLASTIC PIPE SADDLE INSTALLATION

COMPLETE PLUG-IN UNDERGROUND UNITS

| PART NO. | COMPONENTS |
|----------|--|
| UF-PI-3 | PI-3 Kit, 8' hose, H-476, elbow |
| UF-PI-33 | PI-33 kit, TWO 8' hoses, each with H-476 & elbow |
| UF-PI-4 | PI-4 kit, 8' hose, HF-577, elbow |
| UF-PI-5 | PI-5 kit, 8' hose, H-491, elbow |

Order Now for better, more profitable installations.

PI KIT INCLUDES PLASTIC FLOOR FITTING & SADDLE

| PART NO. | PART NO. |
|---------------------------------|---------------------------|
| PI-3-Kit (3" rubber hose) | PI-4 Kit (4" rubber hose) |
| PI-33-Kit (TWO 3" rubber hoses) | PI-5 Kit (5" rubber hose) |

NOTE: Above kits do not include hose assemblies.

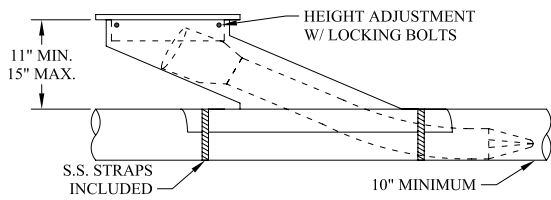

HARVEY DYNAMOMETER, TRUCK AND HEAVY EQUIPMENT FLOOR FITTING

The Harvey HDY Floor Fitting is used for Diagnostic Testing, Bus, or Heavy Equipment Exhaust. The unit consists of a 14-gauge galvanized steel saddle, extension tube, and telescoping body which allows for 4" height adjustment. The exterior is corrosion-resistant coated. The lid is ¼" steel plate and mounted to the ¼" steel flange with a heavy-gauge all S. S. piano hinge for easy maintenance. When open; the lid rests solidly on the floor. Pipe recommendations: (P.V.C. Sched. 40 or Sched. 80, or similar type of pipe). CONSULT LOCAL/STATE BUILDING CODES.

HDY-DYN (FOR DYNAMOMETERS) HDY floor fitting, 8' x 6" stainless steel flexible metal tubing, stainless steel tailpipe adapter, hose guide.

HDY-R5 HDY floor fitting, 8' x 5" neoprene rubber hose, rubber tailpipe adapter, hose guide.

HDY-SF5 HDY floor fitting, 8' x 5" silicone fiberglass hose, adapter, hose guide.

HDY-SF6 HDY floor fitting, 8' x 6" silicone fiberglass hose, adapter, hose guide.

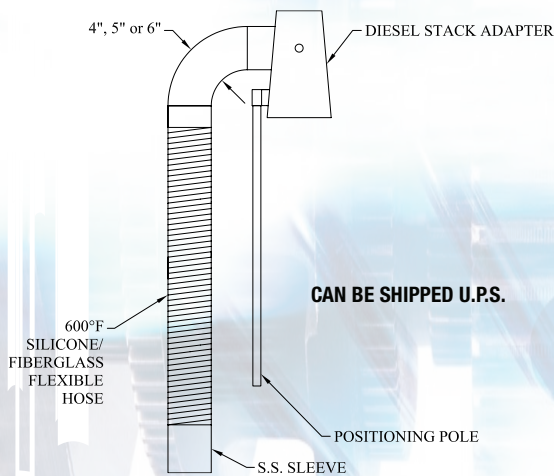

HARVEY DIESEL CANE

The Harvey Diesel Cane is for used with existing exhaust systems when servicing vehicles with overhead diesel stacks. The cane is positioned over the diesel stack and the opposite end is connected to the adapter of the vehicle exhaust system.



HARVEY RECOVER □

HARVEY RECOVER

Used to repair or cover "non repairable" in-ground floor units that are broken or rusted out—causing a safety hazard.

The Harvey Recover is simply placed over the existing "hole" or damaged fitting and attached to the concrete with drive pins through holes provided in the frame. The Recover may also be recessed in the concrete if desired.

Constructed of all cast aluminum, the lid is affixed to the frame with a S.S. replaceable piano hinge. The outside dimensions of the frame are 10" x 12-1/2". The lid measures 8" x 10".

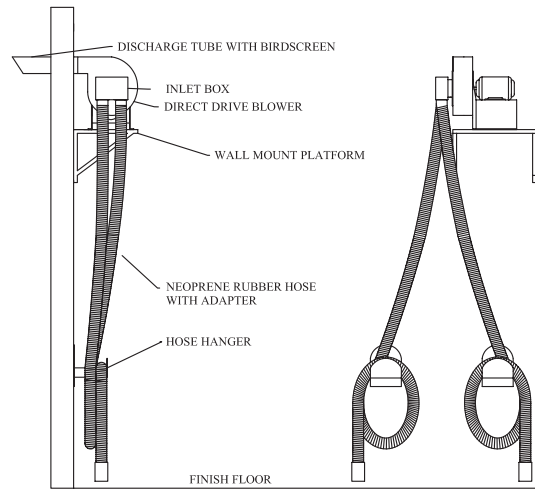

TWO BAY PORTABLE EXHAUST SYSTEM

For use in small garages where Thru-The-Door System is inadequate and the customer does not want the expense of an overhead system. The blower is mounted off the floor between the garage doors.

PORTABLE H-2-BGK



Custom units available
Contact Factory

HARVEY GARAGE EXHAUST KITS

| MODEL | HP | NO. OF HOSE | HOSE LENGTH/SIZE | RECOMMENDED USE |
|---------|-----|-------------|------------------|-----------------------------------|
| H-2-BGK | 1/3 | 2 | 10' x 3" I.D. | Cars |
| H-GK-3 | 1/3 | 1 | 20' x 3" I.D. | Cars |
| H-GK-4 | 1/3 | 1 | 20' x 4" I.D. | Cars, Light Trucks & School Buses |

HARVEY HEAVY DUTY GARAGE EXHAUST KITS

| MODEL | HP | NO. OF HOSE | HOSE LENGTH/SIZE | RECOMMENDED USE |
|------------|----|-------------|------------------|-----------------------------------|
| HD-2-BGK-3 | 1 | 2 | 20' x 3" I.D. | Cars |
| HD-2-BGK-4 | 1 | 2 | 15' x 4" I.D. | Cars |
| HD-GK-4 | 1 | 1 | 30' x 4" I.D. | Cars, Light Trucks & School Buses |

GARAGE KITS IN THE ABOVE CHART INCLUDE:

- Direct drive blower
- Appropriate inlet box
- Required neoprene rubber hoses
- Rubber tailpipe adapter(s)

CONSTRUCTION

Housings, wheels, and frames are welded providing heavy construction and assuring solid, rattle free units. Wheels are supported by heavy cast iron hubs and are static and dynamically balanced. Belt drive units are equipped with variable speed drives.

ACCESSORIES

Various types of installations may require accessories for the blower such as: All-Weather Cover, Back Draft Damper, Vibration Pads, Belt Guard, Acid-Resistant Coating of Air Stream, Sparkproof Construction, Inlet and Outlet Flexible Connections, and Blower Platforms. These and other accessories are available for all Harvey Blowers.

GENERAL

Clockwise rotation wheel and bottom horizontal discharge housing is standard. Discharge may be changed to any one of eight directions at job site or specified on order. Direct drive, BD-7, BD-8 and BD-10 belt drive Blowers are either forward curve or radial blade. All other belt drive Blowers are backward curve.

BLOWER LIMITED WARRANTY

Should any failure due to defective workmanship or material occur within 12 months from date of shipment, replacement of defective part only will be made promptly without charge. This warranty does not cover ordinary wear and tear, abuse, misuse, overloading, altered products, or materials not of seller's manufacture.

DIRECT DRIVE BLOWER PERFORMANCE DATA AND DIMENSIONS

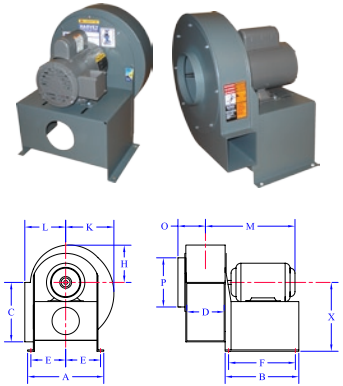

| Model No. | Mtr. H.P. | Wheel Dia. | CFM@ S.P. | | | | A | B | C | D | H | K | L | M | O | P | X | App. Wt. |
|-----------|-----------|------------|-----------|------|--------|------|---------|---------|---------|--------|--------|--------|--------|---------|--------|----|---------|----------|
| | | | 1 1/4" | 2" | 2 1/2" | 3" | | | | | | | | | | | | |
| DD-1 | 1/2 | 9 | 483 | 470 | 440 | 405 | 12 1/2" | 8 | 3 1/2" | 3 1/2" | 6 3/8" | 6 7/8" | 6 3/4" | - | - | 5 | 9 3/8" | 40 |
| DD-2 | 3/4 | 9 | 1290 | 1100 | - | - | 12 1/2" | 8 | 10 3/4" | 6 1/2" | 6 3/4" | 7 1/4" | 7 1/8" | 13 | 4 3/8" | 9 | 9 7/8" | 65 |
| DD-3 | 1 | 10 | 755 | 740 | 705 | 680 | 14 3/4" | 9 | 4 | 3 1/2" | 7 1/4" | 8 | 7 5/8" | - | - | 6 | 11 1/4" | 55 |
| DD-4 | 1 | 10 | 1425 | 1280 | 910 | - | 14 3/4" | 11 1/2" | 11 3/4" | 5 7/8" | 8 | 9 1/8" | 8 1/8" | 14 3/8" | 4 | 10 | 11 1/4" | 70 |
| DD-5 | 1 1/2 | 10 | 1730 | 1600 | 1280 | - | 14 3/4" | 11 1/2" | 11 3/4" | 5 7/8" | 8 | 9 1/8" | 8 1/8" | 14 3/8" | 4 | 10 | 11 1/4" | 75 |
| DD-6 | 2 | 10 | 2240 | 2130 | 1850 | 1130 | 14 3/4" | 11 1/2" | 11 3/4" | 8 | 8 | 9 1/8" | 8 1/8" | 15 1/2" | 5 | 10 | 11 1/4" | 80 |

BELT DRIVE BLOWER PERFORMANCE DATA AND DIMENSIONS



| Model No. | Mtr. H.P. | Wheel Dia. | CFM@ S.P. | | | A | B | C | D | H | K | L | M | N | P | R | T | X | App. Wt. |
|-----------|-----------|------------|-----------|--------|------|---------|---------|---------|---------|---------|---------|---------|---------|---------|---------|---------|---------|---------|----------|
| | | | 1 1/2" | 2 1/2" | 3" | | | | | | | | | | | | | | |
| BD-7 | 3/4 | 7 | 980 | 829 | 770 | 9 1/8" | 13 | 8 1/4" | 5 3/8" | 6 | 6 3/4" | 6 7/8" | 20 1/8" | 3 3/4" | 8 | - | 18 1/2" | 12 | 70 |
| BD-8 | 1 | 9 | 1400 | 1217 | 1125 | 10 3/8" | 13 | 10 3/4" | 6 1/2" | 6 3/4" | 7 1/4" | 20 3/4" | 4 5/16" | 9 | - | 18 1/2" | 12 | 75 | |
| BD-9 | 1 1/2 | 10 | 2162 | 1936 | 1810 | 12 7/8" | 13 | 11 3/4" | 8 | 7 7/8" | 9 1/8" | 8 1/16" | 21 1/2" | 6 | 12 7/8" | - | 18 1/2" | 14 | 100 |
| BD-11 | 2 | 12 | 3059 | 2716 | 2550 | 16 5/8" | 13 1/2" | 13 3/4" | 9 5/8" | 10 1/8" | 11 1/2" | 10 1/2" | 23 3/8" | 6 3/8" | 13 3/4" | 12 3/4" | 20 | 17 | 150 |
| BD-12 | 2 | 15 | 3850 | 3217 | 2909 | 19 1/4" | 15 1/2" | 16 1/4" | 11 1/4" | 12 3/8" | 14 1/8" | 12 3/8" | 26 7/8" | 7 1/2" | 16 1/8" | 14 7/8" | 22 | 17 7/8" | 180 |
| BD-13 | 3 | 15 | 4608 | 4125 | 3855 | 19 1/4" | 15 1/2" | 16 1/4" | 11 1/4" | 12 3/8" | 14 1/8" | 12 3/8" | 26 7/8" | 7 1/2" | 16 1/8" | 14 7/8" | 22 | 17 7/8" | 200 |
| BD-14 | 3 | 18 | 5715 | 4863 | 4424 | 23 1/8" | 17 | 19 5/8" | 14 1/4" | 15 | 17 1/8" | 14 5/8" | 30 5/8" | 9 1/8" | 16 1/8" | 18 3/4" | 25 | 21 7/8" | 295 |
| BD-15 | 5 | 18 | 6836 | 6457 | 6077 | 23 1/8" | 17 | 19 5/8" | 14 1/4" | 15 | 17 1/8" | 14 5/8" | 30 5/8" | 9 1/8" | 19 5/8" | 18 3/4" | 25 | 21 7/8" | 315 |
| BD-16 | 5 | 20 | 8150 | 7174 | 6718 | 25 | 17 | 21 1/2" | 15 7/8" | 16 1/2" | 18 3/4" | 15 3/4" | 31 1/2" | 10 | 21 1/2" | 20 1/8" | 25 | 23 3/4" | 335 |
| BD-17 | 5 | 22 | 9183 | 7895 | 7184 | 27 3/8" | 16 1/2" | 24 | 17 3/8" | 18 3/4" | 20 7/8" | 17 3/4" | 32 3/4" | 10 5/8" | 23 3/8" | 22 5/8" | 26 | 26 1/8" | 360 |

"ALL AMCA APPROVED"

HIGH PERFORMANCE BELT DRIVE BLOWER DATA AND DIMENSIONS

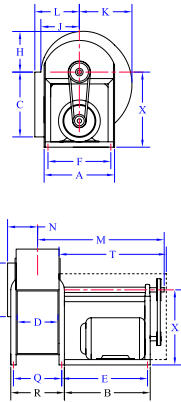

| Model No. | Mtr. H.P. | Wheel Dia. | CFM@ S.P. | | | A | B | C | D | H | K | L | M | N | P | R | X | App. Wt. |
|-----------|-----------|------------|-----------|------|------|---------|---------|---------|---------|---------|---------|---------|---------|---------|---------|---------|---------|----------|
| | | | 3" | 4" | 5" | | | | | | | | | | | | | |
| HP-18 | 1 1/2 | 10 | 1810 | 1550 | 1240 | 12 7/8" | 13 | 11 3/4" | 8 | 7 7/8" | 9 1/8" | 8 1/16" | 19 5/8" | 6 | 12 7/8" | - | 14 | 110 |
| HP-19 | 2 | 12 | 2550 | 2170 | - | 16 3/8" | 13 1/2" | 13 3/4" | 9 5/8" | 10 1/8" | 11 1/2" | 10 1/2" | 23 3/8" | 6 3/8" | 13 3/4" | 12 3/4" | 17 | 160 |
| HP-20 | 3 | 15 | 3855 | 3292 | - | 19 1/4" | 15 1/2" | 16 1/4" | 11 1/4" | 12 3/8" | 14 1/8" | 12 3/8" | 26 7/8" | 7 1/2" | 16 1/8" | 14 7/8" | 17 7/8" | 210 |
| HP-21 | 5 | 18 | 6077 | 5317 | 4368 | 23 1/8" | 17 | 19 5/8" | 14 1/4" | 15 | 17 1/8" | 14 5/8" | 30 5/8" | 9 1/8" | 19 5/8" | 18 3/4" | 21 7/8" | 325 |
| HP-22 | 7 1/2 | 22 | 9350 | 8137 | 6502 | 27 3/8" | 16 1/2" | 24 | 17 3/8" | 18 3/4" | 20 7/8" | 17 3/4" | 32 3/4" | 10 5/8" | 23 3/8" | 22 5/8" | 26 1/8" | 375 |

Belt Drive Blowers up to 20,000 CFM also available.

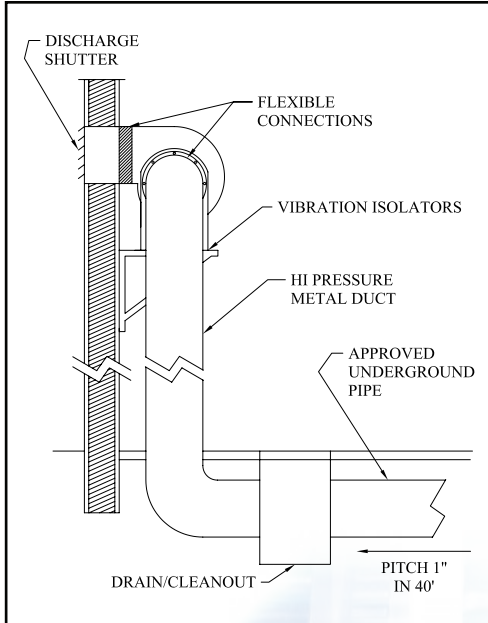

STACK AND BLOWER INSTALLATION

The blower should be mounted on a rigidly constructed level platform, approximately 17' high as noted above, or suspended with threaded rod.

The inlet and outlet duct should be connected to the blower with a flexible connection. Locate the blower in a space large enough to permit ample air circulation. When installing the blower outside the building it must be protected from the elements. All weather covers are available for this purpose.

Bottom horizontal discharge is standard. However, it can be changed to any one of eight positions at job site or when the unit is ordered to accommodate exhausting of the blower through the roof or out the side of the building.

GENERAL CFM RECOMMENDATIONS

- 250-300 CFM per outlet for passenger cars and light trucks.
- 300-350 CFM per outlet for medium trucks.
- 450-500 CFM per outlet for diesel trucks and buses up to 500 HP.
- 600-650 CFM per outlet for diesel engines over 600 HP.

THRU-WALL EXHAUST SYSTEMS

Many installations require wall ports in place of door ports. Available for this application are stainless steel wall tube assemblies.

SPECIFY WALL WIDTH.

| PART NO. | COMPONENTS |
|----------|--|
| HWT-51 | H3451 Door port, SS. wall tube, 8' x 2-1/2" hose, H-476 adapter. |
| HWT-56 | H-3456 Door port, SS. wall tube, 8' x 3" hose, HF-477 adapter. |
| HWT-57 | H-3457 Door port, SS. wall tube, 8' x 4" hose, HF-577 adapter. |

HARVEY DOOR PORTS

Door Ports are all cast aluminum for years of trouble free service. They are supplied with all hardware necessary for installation.

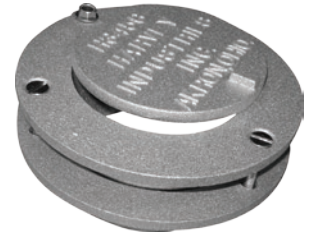

| PART NO. | COMPONENTS |
|----------|---|
| H-3451 | For door panel more than 1/2" thick, 2 1/2" hose. |
| H-3453 | For door panels 1/2" thick or less, 2 1/2" hose. |
| H-3456 | Universal, all panel sizes, 3" hose. |
| H-3457 | Universal, all panel sizes, 4" hose. |

NOTE: Check Local/State Codes, many Cities/States now require blower assist. Our TWO BAY EXHAUST SYSTEM would then be recommended.

THRU-DOOR EXHAUST SYSTEM

The Harvey Thru-The-Door System is designed for service stations and garages where the door is directly behind the vehicle.



| PART NO. | COMPONENTS |
|----------|---|
| H-345 | H-3451 door port, 8' x 2-1/2" neoprene rubber hose, H-476 tailpipe adapter. |
| H-445 | H-3453 door port, 8' x 2-1/2" neoprene rubber hose, H-476 tailpipe adapter. |
| H-456 | H-3456 door port, 8' x 3" neoprene rubber hose, HF-477 tailpipe adapter. |
| H-457 | H3457 door port, 8' x 4" neoprene rubber hose, HF-577 tailpipe adapter. |

NOTE: for dual exhaust automobiles, two Thru-The-Door units may be installed in the garage door, or you may wish to utilize a "Y" Harness in conjunction with H-456 or H-457.

HARVEY FUME EXTRACTION ARM

| PRODUCT NO | SIZE (I.D.) | LENGTH |
|------------|-------------|--------|
| HFA-610 | 6" I.D. | 10' |
| HFA-614 | 6" I.D. | 14' |

Custom lengths available. PLEASE CONTACT FACTORY.

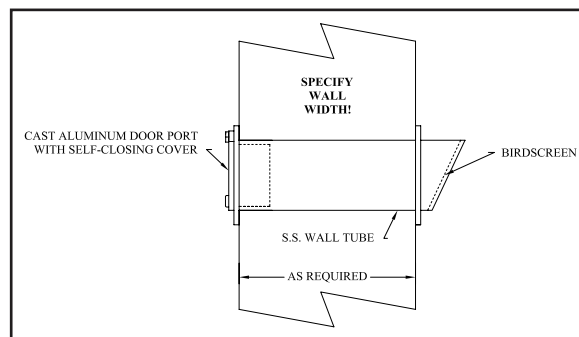
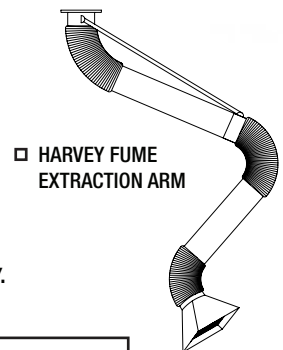

□ UNDERGROUND SYSTEM



HARVEY "TWIST-LOCK" NON-CRUSH RUBBER EXHAUST HOSE

HARVEY "TWIST-LOCK" hose represents the latest advancements in technology and fabrication of rubber hose for our industry. Under normal service conditions the hose is heat resistant in excess of 500°F. The "TWIST-LOCK" feature enables an individual to connect several lengths of hose together without the use of couplers.

RUBBER HOSE IS NOTE RECOMMENDED FOR DYNAMOMETERS

"TWIST-LOCK" HOSE PACKAGING

| Size (ID) | Part No. Single 11' Length | Part No. Standard Carton |
|--------------------------|----------------------------|--------------------------|
| 2" | H-2011 | H-2055 (5-lengths) |
| 2 1/2" | H-2511 | H-2555 (5-lengths) |
| *3" | H-3011 | H-3044 (4-lengths) |
| *3-1/2" | H-3511 | H-3533 (3-lengths) |
| *4" | H-4011 | H-4022 (2-lengths) |
| *5" | Not | H-5010 '+' |
| *6" | Twist Lock | H-6011 |
| *RECOMMENDED BY O.S.H.A. | | |
| +' 10' LENGTH | | |



HARVEY "Y" HARNESS

H-30-3-57 also available, same as H-30-3-47, but supplied with HF-577 adapters.

H-30-3-47 2-4' x 3" hose, 1-2' x 3" hose, 1-H-483 "Y" fitting, 2-HF-477 adapters.

H-40-4-57 2-4' x 4" hose, 1-2' x 4" hose, 1-H-484 "Y" fitting, 2-HF-577 adapters.

REPLACEMENT HOSE ASSEMBLIES FOR UNDERGROUND SYSTEMS

HA-3 8' X 3" I.D. rubber hose, H-476 tailpipe adapter, HG-30 hose guide.

HA-4 8' X 4" I.D. rubber hose, H-577 tailpipe adapter, HG-40 hose guide.



□ WILL NOT KINK

ACCORDIAN FLEX HOSE MEASURED EXTENDED

*H-40-20-AF 4" ID x 20' per carton
*H-50-12-AF 5" ID x 12' per carton

TAILPIPE ADAPTERS

To avoid continual replacement of exhaust hose, tailpipe adapters should be used. Harvey tailpipe adapters are available for all sizes of hose and tubing, and are manufactured in rubber and stainless steel.



HF-477- Rubber oval shaped (3" x 6-1/2") for twin tailpipes. Fits 3" or 4" hose.

HF-577- Rubber oval shaped (3" x 8-1/2") for twin tailpipes. Fits 3" or 4" hose.



HF-250, HF-300, HF-350, HF-400 - Rubber tailpipe adapters which can be adapted to 2-1/2", 3", or 4" hose.

HF-250 for tailpipes up to 2-1/2" O.D.
HF-300 for tailpipes up to 3" O.D.
HF-350 for tailpipes up to 3-1/2" O.D.
HF-400 for tailpipes up to 4" O.D.

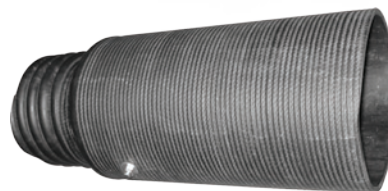

H-491- Rubber diesel adapter for stacks up to 6" in diameter. Threads onto 4" or into 5" hose. Rod through adapter acts as stop.

H-691- Same as H-491 but threads into 6" hose only.



**AR SERIES RUBBER
STACK/TAILPIPE ADAPTER**

H-Smooth bore mounting base for use with smooth bore hose.

- AR-4 - 4" hose
- AR-5 - 5" hose
- AR-6 - 6" hose



H-470 & H-471 - Universal rubber adapters for tailpipes up to 3" diameter.
H-470 for 2-1/2" hose.
H-471 for 2" or 3" hose.
H-476 - Same as H-471 with chain and hook in place of snaps.

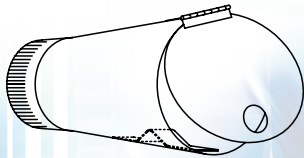

**STAINLESS STEEL TAPERED
ADAPTER WITH SPRING
CLOSING COVER**

Specify for rubber, Silicone Fiberglass, or Metal Tubing.

- TAC-3 - 3" Hose or Tubing
- TAC-4 - 4" Hose or Tubing
- TAC-5 - 5" Hose or Tubing
- TAC-6 - 6" Hose or Tubing

Also available without spring closing cover - eliminate "C" from above product number.



HOSE COUPLERS

Cast aluminum hose coupler used to connect various lengths of rubber hose when "Twist Lock" feature not available.

- HAC-30 for 3" rubber hose.
- HAC-40 for 4" rubber hose.
- HAC-50 for 5" rubber hose.



HOSE GUIDES

Standard with all Harvey underground units. The hose guide serves two purposes; to guide the rubber hose easily through the underground system and to prevent rags, etc. from being sucked into the system. Also available for metal tubing.

- HG-30 - 3" hose.
- HG-40 - 4" hose.
- HG-50 - 5" hose.



**H-3422 FLOOR
FITTING (2-1/2" HOSE)**

Old style floor fitting, replacement units available.

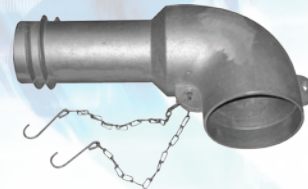

H-490 - Diesel adapter, cast aluminum for 3" & 4" stacks, threads into 4" hose.



**CAST ALUMINUM
"Y" FITTINGS**

For use in "Y" harnesses.

- H-481 - 3" hose.
- H-484 - 4" hose.
- H-482 - 2-1/2" hose (Molded Rubber - Not Aluminum).



ENERGY SAVING DAMPERS

Mounted in the hose drop of an overhead system to cut off the majority of air flow when not in use.

- ES-130 for 3" hose.
- ES-140 for 4" hose.
- ES-150 for 5" hose.



**ELBOW FOR LIFTING
OVERHEAD DROPS**

Cast aluminum elbow joins two hose lengths and eliminates kinking of hose when pulled out of the way. Used in place of damper.

- H-3AEL - 3" hose.
- H-4AEL - 4" hose.
- H-5AEL - 5" hose.



**OVERHEAD DUCT
COUPLERS**

Harvey Overhead Duct Couplers simplify installation of overhead rubber drops. One end of the cast aluminum coupler threads into the rubber hose and the other end slips over stub of the duct work. A bolt through the assembly completes installation of the overhead drop.

- OHC-30-3" hose, 3" O.D. stub.
- OHC-40-4" hose, 4" O.D. stub.
- OHC-50-5" hose, 5" O.D. stub.



□ HARVEY HRX-812 EXHAUST RAIL

SLEEK STYLING
EASY TO INSTALL
HEAVY DUTY CONSTRUCTION
EASY-GLIDE TROLLEY MOVEMENT
EFFICIENT AIRFLOW

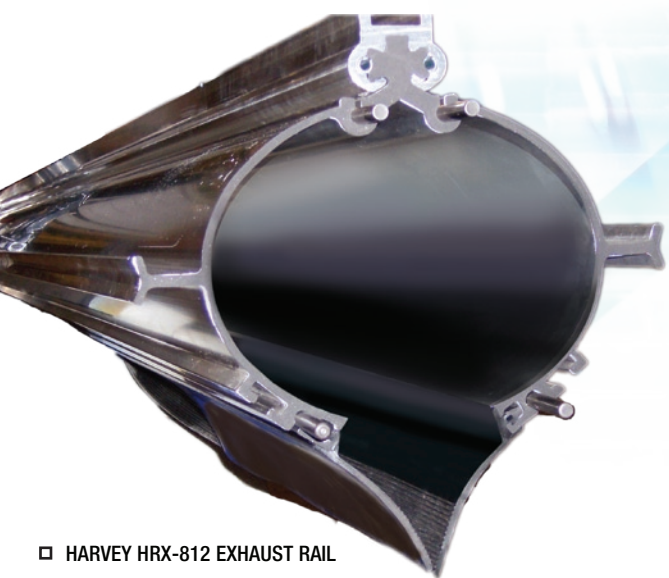

□ HARVEY HRX-812 EXHAUST RAIL

HARVEY

INDUSTRIES, INC.

WWW.HARVEYEXHAUST.COM

DISTRIBUTED BY:



2212 Camplain Road
Hillsborough, NJ 08844
1-888-8FC-LIFT



ALL HARVEY PRODUCTS "MADE IN U.S.A."

CARBON MONOXIDE AND TOXIC FUME EXHAUST SYSTEMS • BLOWERS • HOSES • ACCESSORIES